

A Division of Systems, LLC

**DLM**  
**DOCK LEVELER**  
**MANUFACTURING**

# Portable Steel Yard Ramp

## Owner's/User's Manual

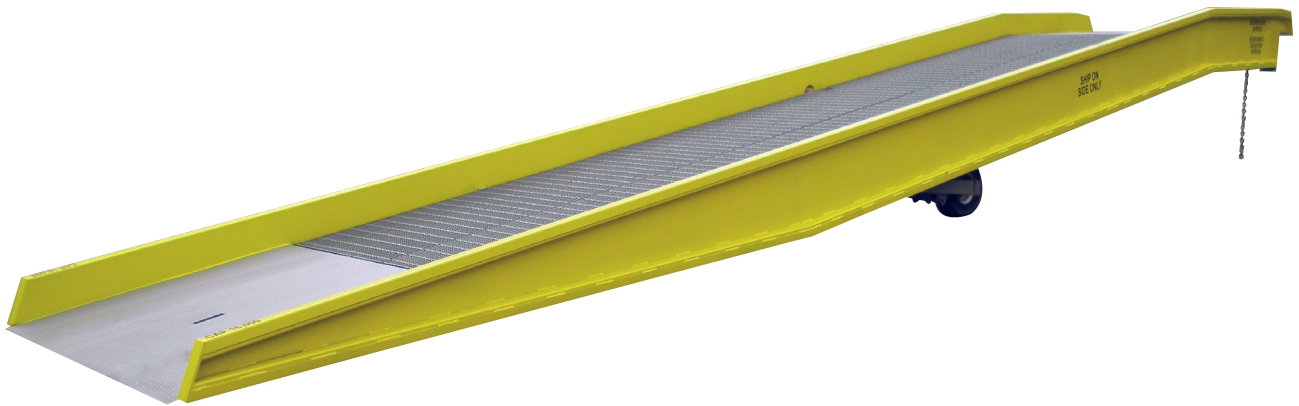

**DLM** • Division of Systems, LLC • W194 N11481 McCormick Drive • Germantown, WI 53022  
800.643.5424 • fax: 262.255.5917 • [www.dlmdocks.com](http://www.dlmdocks.com) • [techservices@loadingdocksystems.com](mailto:techservices@loadingdocksystems.com)

Printed in U.S.A.  
© 2018 Systems, LLC - All Rights Reserved

Manual No. 4111-0079  
Sept. 2018

# Table of Contents

	Page
<b>Precautions</b>	
Recognize Precautionary Information .....	1
General Operational Precautions .....	1
Operational Precautions .....	2
Safety Decals.....	4
Owner's/User's Responsibilities.....	6
<b>Introduction</b>	
General Information .....	8
Component Identification.....	9
<b>Installation</b>	
Installation Precautions .....	10
Unloading Yard Ramp.....	11
<b>Operation</b>	
Operational Precautions .....	12
Operating Instructions .....	12
<b>Maintenance</b>	
Maintenance Precautions.....	14
Periodic Maintenance .....	15
<b>Troubleshooting</b>	
Troubleshooting.....	18
<b>Parts</b>	
Pump .....	20
Hydraulic System .....	22
<b>Miscellaneous</b>	
Customer Information .....	23
Warranty.....	Back Cover

## Recognize Precautionary Information

### Safety-Alert Symbol



The Safety-Alert Symbol is a graphic representation intended to convey a safety message without the use of words. When you see this symbol, be alert to the possibility of death or serious injury. Follow the instructions in the safety message panel.

### **DANGER**

The use of the word DANGER signifies the presence of an extreme hazard or unsafe practice which will most likely result in death or severe injury.

### **WARNING**

The use of the word WARNING signifies the presence of a serious hazard or unsafe practice which could result in death or serious injury.

### **CAUTION**

The use of the word CAUTION signifies possible hazard or unsafe practice which could result in minor or moderate injury.

### **NOTICE**

The use of the word NOTICE indicates information considered important, but not hazard-related, to prevent machine or property damage.

## **SAFETY INSTRUCTIONS**

Indicates a type of safety sign, or separate panel on a safety sign, where safety-related instructions or procedures are described.

## General Operational Precautions



Read and understand the Owner's/User's Manual and become thoroughly familiar with the equipment and its controls before operating the equipment.

Never operate equipment while a safety device or guard is removed or disconnected.

Never remove DANGER, WARNING, or CAUTION signs, Placards or Decals on the equipment unless replacing them.

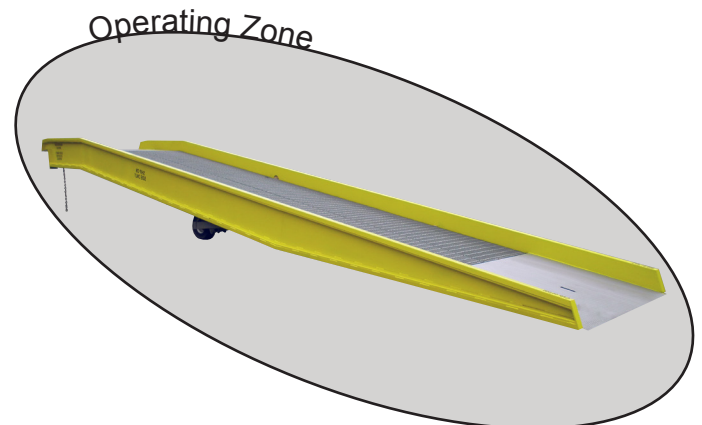

Figure 1

Do not start the equipment until all unauthorized personnel in the area have been warned and have moved outside the operating zone (see Figure 1).

Remove any tools or foreign objects from the operating zone before starting.

Keep the operating zone free of obstacles that could cause a person to trip or fall.



**WARNING:** This product can expose you to chemicals including lead, which are known to the State of California to cause cancer or birth defects or other reproductive harm. For more information go to [www.P65Warnings.ca.gov](http://www.P65Warnings.ca.gov)

# PRECAUTIONS

## Operational Precautions



Learn the safe way to operate this equipment. Read and understand the manufacturer's instructions. If you have any questions, ask your supervisor.

### **DANGER**



Stay clear of dock leveling device when transport vehicle is entering or leaving area.



Do not move or use the dock leveling device if anyone is under or in front of it.



Keep hands and feet clear of pinch points. Avoid putting any part of your body near moving parts.

### **WARNING**



Chock/restrain all transport vehicles. Never remove the wheel chocks or release the restraining device until loading or unloading is finished, and transport driver has been given permission to drive away.



Do not use a broken or damaged dock leveling device or restraining device. Make sure proper service and maintenance procedures have been performed before using.



Make sure lip overlaps onto transport vehicle bed at least 4 in. (102 mm).



Keep a safe distance from both side edges.

**Operational Precautions**

**! WARNING**

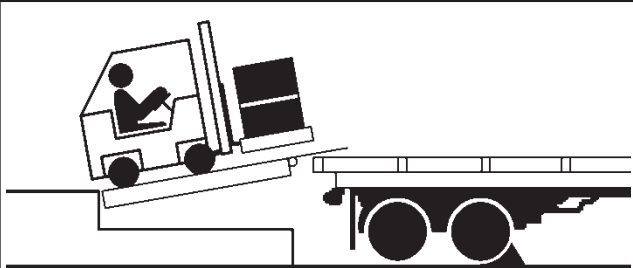

Do not use dock leveling device if transport vehicle is too high or too low.

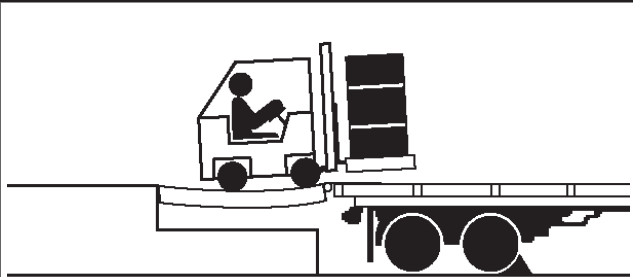

Do not overload the dock leveling device.



Do not operate any equipment while under the influence of alcohol or drugs.

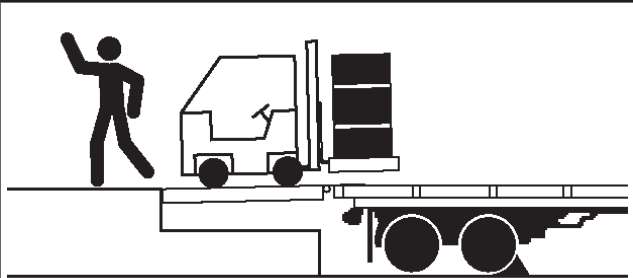

Do not leave equipment or material unattended on dock leveling device.

# PRECAUTIONS

## Safety Decals

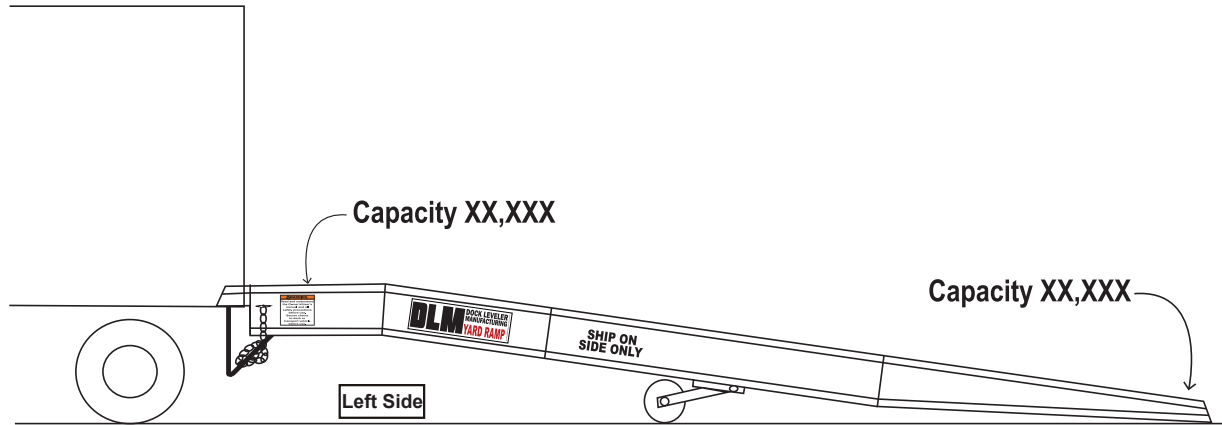
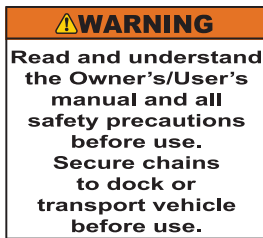

Figure 2



Decal 1751-0966 will have 2 positions one on the right side as shown and one on the left side in same position



Decal 1751-0972 will have 2 positions one on the right side as shown and one on the left side in same position

Capacity XX,XXX  
 Capacity XX,XXX  
 Capacity XX,XXX  
 Capacity XX,XXX

Capacity Decals will have 4 positions on top of rail  
 2 at the top on the right and left side and  
 2 at the base on the right and left side  
 1751-1030 - Capacity 16,000  
 1751-1031 - Capacity 20,000  
 1751-1032 - Capacity 25,000  
 1751-1033 - Capacity 30,000

This page intentionally left blank.

# OWNER'S/USER'S RESPONSIBILITIES

---

- 1) The manufacturer shall provide to the initial purchaser and make the following information readily available to the owners/users and their agents, all necessary information regarding Safety Information, Operation, Installation and Safety Precautions, Recommended Initial and Periodic Inspections Procedures, Planned Maintenance Schedule, Product Specifications, Troubleshooting Guide, Parts Break Down, Warranty Information, and Manufacturers Contact Information, as well as tables to identify the grade(slope) for all variations of length or configuration of the dock leveling device and information identifying the maximum uncontrolled drop encountered when sudden removal of support while in the working range of the equipment.
- 2) When selecting loading dock safety equipment, it is important to consider not only present requirements but also future plans and any possible adverse conditions, environmental factors or usage. The owners/users shall provide application information to the manufacturer to receive recommendations on appropriate equipment specifications and capacity.
- 3) The owner/user must see all nameplates, placards, decals, instructions and posted warnings are in place and legible and shall not be obscured from the view of the operator or maintenance personnel for whom such warnings are intended for. Contact manufacturer for any replacements.
- 4) Dock leveling devices may become hazardous if the manufacturer's instructions regarding modifications or adjustments are not followed. Modifications or alterations of dock leveling devices shall only be made with prior written approval from the original manufacturer. These changes shall be in conformance with all applicable provisions of the MH30.1 standard and shall also satisfy all safety recommendations of the original equipment manufacturer of the particular application.
- 5) The owner/user should recognize the inherent dangers of the interface between the loading dock and the transport vehicle. The owner/ user should, therefore, train and instruct all operators in the safe operation and use of the loading dock equipment in accordance with manufacturer's recommendations and industry standards. Effective operator training should also focus on the owner's/user's company policies, operating conditions and the manufacturer's specific instructions provided with the dock leveling device. Maintaining, updating and retraining all operators on safe working habits and operation of the equipment, regardless of previous experience, should be done on a regular basis and should include an understanding and familiarity with all functions of the equipment. Owners/users shall actively maintain, update and retrain all operators on safe working habits and operations of the equipment.
- 6) An operator training program should consist of, but not necessarily be limited to, the following:
  - a) Select the operator carefully. Consider the physical qualifications, job attitude and aptitude.
  - b) Assure that the operator reads and fully understands the complete manufacturer's owners/users manual.
  - c) Emphasize the impact of proper operation upon the operator, other personnel, material being handled, and equipment. Cite all rules and why they are formulated.
  - d) Describe the basic fundamentals of the dock leveling device and components design as related to safety, e.g., mechanical limitation, stability, functionality, etc.
  - e) Introduce the equipment. Show the control locations and demonstrate its functions. Explain how they work when used properly and maintained as well as problems when they are used improperly.
  - f) Assure that the operator understands the capacity rating, nameplate data, placards and all precautionary information appearing on the dock leveling device.
  - g) Supervise operator practice of equipment.
  - h) Develop and administer written and practical performance tests. Evaluate progress during and at completion of the course.
  - i) Administer periodic refresher courses. These may be condensed versions of the primary course and include on-the-job operator evaluation.



# OWNER'S/USER'S RESPONSIBILITIES

---

- 7) Loading dock safety equipment should never be used outside of its vertical working range, or outside the manufacturer's rated capacity. It shall also be compatible with the loading equipment and other conditions related to dock activity. Please consult the manufacturer if you have any questions as to the use, vertical working range or capacity of the equipment. Only properly trained and authorized personnel should operate the equipment.
- 8) It is recommended that the transport vehicle is positioned as close as practical to the dock leveling device and in contact with both bumpers. When an industrial vehicle is driven on or off a transport vehicle during loading and unloading operations, the transport vehicle parking brakes shall be applied and wheel chocks or a restraining device that provides equal or better protection of wheel chocks shall be engaged. Also, whenever possible, air-ride suspension systems should have the air exhausted prior to performing said loading and unloading operations.
- 9) When goods are transferred between the loading dock and a trailer resting on its support legs/ landing gear instead of a tractor fifth wheel or converter dolly, it is recommended that an adequate stabilizing device or devices shall be utilized at the front of the trailer.
- 10) In order to be entitled to the benefits of the standard product warranty, the dock safety equipment must have been properly installed, maintained and operated in accordance with all manufacturer's recommendations and/ or specified design parameters and not otherwise have been subject to abuse, misuse, misapplication, acts of nature, overloading, unauthorized repair or modification, application in a corrosive environment or lack of maintenance. Periodic lubrication, adjustment and inspection in accordance with all manufacturers' recommendations are the sole responsibility of the owner/user.
- 11) Manufacturer's recommended maintenance and inspection of all dock leveling devices shall be performed in conformance with the following practices: A planned maintenance schedule program must be followed, only trained and authorized personnel shall be permitted to maintain, repair, adjust and inspect dock leveling devices, and only the use of original equipment manufacturer parts, manuals, maintenance instructions, labels, decals and placards or their equivalent. Written documentation of maintenance, replacement parts or damage should be kept. In the event of damage, notification to the manufacturer is required.
- 12) Loading dock devices that are structurally damaged or have experienced a sudden loss of support while under load, such as might occur when a transport vehicle is pulled out from under the dock leveling device, shall be removed from service, inspected by a manufacturer's authorized representative, and repaired or replaced as needed or recommended by the manufacturer before being placed back in service.

# INTRODUCTION

---

## General Information

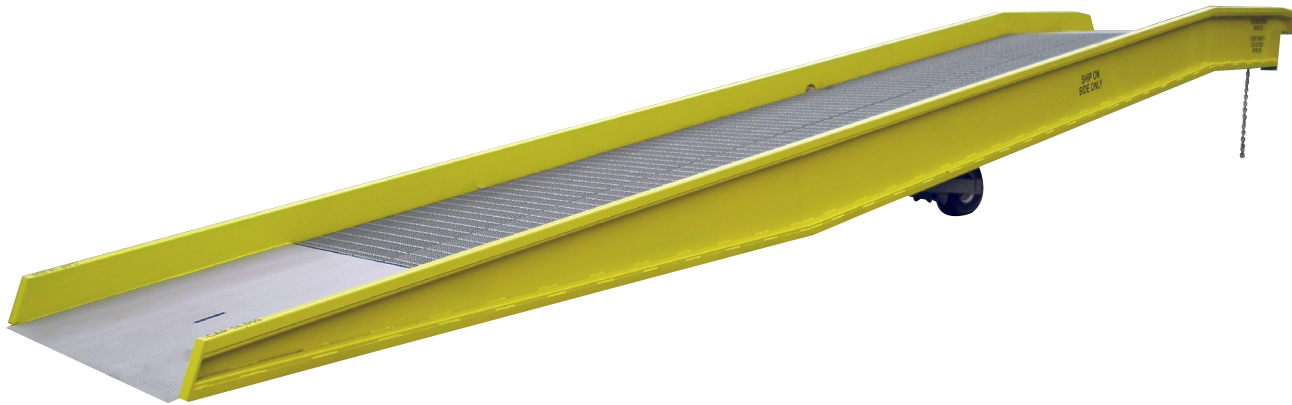

Figure 3

This manual provides current information on the portable steel Yard Ramp. Due to ongoing product improvement, some parts may have changed, along with operation and troubleshooting methods. This manual describes these changes where applicable.

The portable steel Yard Ramp allows for traffic to move from the dock level down to the ground or from the ground up into the back of a truck, which helps loading/unloading flow smoothly. The 18" industrial solid rubber pneumatic tires allow for easy movement of the Yard Ramp around your shipping yard to have you ready in minutes to begin loading/unloading. The hydraulic adjustment system permits fast reliable height adjustment of the Yard Ramp with virtually any trailer bed height.

Each Yard Ramp has been factory tested to ensure satisfactory operation.

Yard Ramps are available in the following sizes, weight capacities, and options:

### Width

70" (1778 mm)  
84" (2134 mm)

### Length

30 ft (9144 mm)  
36 ft (10 973 mm)

### Capacity (CIR\*)

16,000 lb (7257 kg)  
20,000 lb (9072 kg)  
25,000 lb (11 340 kg)  
30,000 lb (13 608 kg)

\* CIR (Comparative Industry Rating)

Custom length and width Yard Ramps are available.

Call DLM to discuss options to meet your specific needs.

Technical Service at 800-643-5424 or [techservices@loadingdocksystems.com](mailto:techservices@loadingdocksystems.com)

## Component Identification

Inspect package and all components. Report any missing or damaged items immediately and note on the shipping Bill Of Lading (BOL).

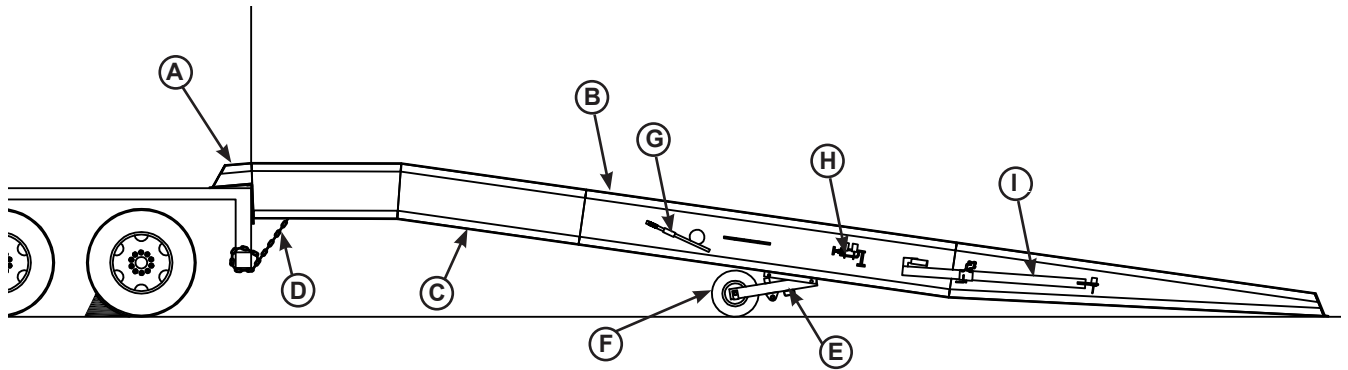

Figure 4 - Truck to Ground

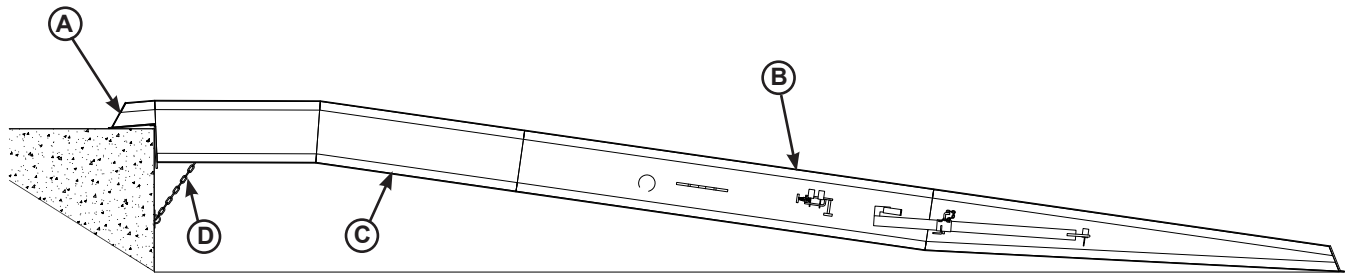

Figure 5 - Dock to Ground

A — Lip  
B — Platform  
C — Girders

D — Safety Chain  
E — Undercarriage Assembly  
F — Rubber Wheels

G — Pump Handle  
H — Ramp Clamp  
I — Tow Bar

# INSTALLATION

---

## Installation Precautions

### **WARNING**

The Yard Ramp is heavy. Use a lifting device and chains with the appropriate lifting capacity and reach.

Always use the lifting brackets provided with the unit whenever lowering or lifting a dock leveler into or out of a pit.

### **NOTICE**

DO NOT remove the safety tie down that is restraining the undercarriage assembly prior to lowering the unit onto its wheels.

### **NOTICE**

Prior to shipment from factory, all hydraulic fittings and connections are inspected for tightness and leaks. However, it is important to recheck these connections prior to use, as they may loosen during shipment.

All Yard Ramp hydraulic systems are factory filled to the proper level. If a leak has occurred during shipment, with the ramp resting on its wheels and in the fully lowered position, check the fluid level in the pump by removing the filler plug (item 14 on page 18). If the fluid level is low (more than 1" below the filler hole), add Enerpac 1507 fluid.

## Unloading Yard Ramp

### Unloading Yard Ramp

If an overhead crane of sufficient capacity is not available, use a forklift with a minimum rated capacity of 8,000 pounds to unload Yard Ramp. Specialty or custom size Yard Ramps which exceed the standardized offerings per sizes in width, length or rated capacity will need a recommendation from Technical Services for forklift capacity due to additional weight.

A nylon sling of at least 48" in length is recommended. The sling may be of the "2 eye" or "endless" configuration. A minimum rated capacity of 10,000 pounds for the basket method of lifting is recommended.

### **WARNING**

If mast height of the forklift will not allow sling usage, position forks beneath the upper side of the ramp and above the grating. Do not attempt to lift the Yard Ramp from the lower side of the unit.

Additional information on slings and hitches can be supplied by sling providers.

Push both forks of the forklift as close together as possible in the center of the forklift, then position forklift forks above the ramp. Feed the sling through the side mounted lifting lug and position one loop of the sling over each fork to within 24 inches of the forklift carriage, thus creating a basket lift. Lift the Yard Ramp until it clears the floor of the trailer by a minimum of 4 inches. Move away from the trailer and lower the ramp to the ground.

To lower the Yard Ramp onto its wheels, position the forklift on the underside of the Yard Ramp. Attach sling as described above; lift the Yard Ramp and place the front lip (the end with the chains) on a stack of three pallets, and lower the ramp so that the rear lip touches the ground. Tilt forks back fully and move slowly away from the Yard Ramp, lowering the forks at the same time. Continue moving and lowering the forks until the ramp is resting on its wheels. Remove the sling.

When unit is lowered onto its wheels, remove the safety tie down that is restraining the undercarriage assembly.

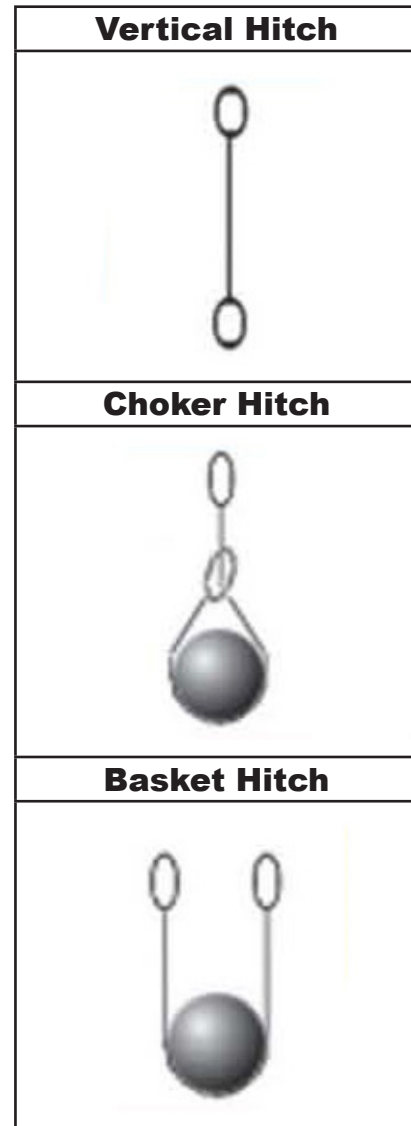

Figure 6

# OPERATION

## Operational Precautions

### **DANGER**

Stay clear of Yard Ramp when transport vehicle is entering or leaving dock area.

DO NOT move or use the Yard Ramp if anyone is under or in front of Yard Ramp.

Keep hands and feet clear of pinch points. Avoid putting any part of your body near moving parts.

### **WARNING**

Only trained personnel should operate the Yard Ramp.

DO NOT use a broken or damaged Yard Ramp. Make sure proper service and maintenance procedures have been performed on leveler before using.

Transport vehicle wheels must be chocked unless a vehicle restraint is used. Never remove the wheel chocks until loading/unloading is finished and transport driver has been given permission to leave.

Make sure platform lip rests on the transport vehicles bed with at least 4 in. (102 mm) of overlap.

Maintain a safe distance from side edges of Yard Ramp during the loading/unloading process.

### **WARNING**

DO NOT overload the Yard Ramp.

DO NOT operate any equipment while under the influence of alcohol or drugs.

DO NOT leave equipment or material unattended on the Yard Ramp.

## Operating Instructions

### Balance

Wheels are located near the balance point of the Yard Ramp with the heavy side on the approach (or low) end for ease of operation, and to make the Yard Ramp trail properly when being towed. The balance will shift as the Yard Ramp elevation is increased.

### Transporting

Release hydraulic pressure (rotate pump release valve handle counterclockwise; refer to item 22 on page 18), and let Yard Ramp settle slowly to its lowest position. Leave pump release valve open while Yard Ramp is being towed to prevent damage to the hydraulic system. Towing speed will be governed by prevailing conditions, but should not be such as to cause severe jostling. Towing speeds should not exceed 5 mph; off road towing must be accompanied by appropriate suspension option.

The ramp clamp is intended for short towing distances and precise positioning of Yard Ramp units.

Tow bars are intended for longer distances. Over the road towing is limited by governing state and federal laws.



Figure 7 - Tow Bar



Figure 8 - Ramp Clamp

## Operating Instructions (continued)

### Elevating

Open pump vent plug/drain cock (item 34 on page 18) by making two complete turns counterclockwise. The vent plug/drain cock must be partially open while operating pump. Close pump release valve (item 22 on page 18) by rotating handle clockwise or pushing handle toward mid-section of ramp.

Install pump handle, stored on side of the Yard Ramp, onto the pump actuator pin (item 13 on page 18) which is accessible through an opening in the grating. Actuate pump handle with long strokes parallel to Yard Ramp until lip of Yard Ramp is higher than the transport vehicle bed. Return pump handle to holder.

**Note:** Numerous cycles of the handle are required to prime the system after shipment or following extended periods without use.

### **WARNING**

Do not continue pressurizing cylinders after they reach maximum height.

### Positioning

Position the Yard Ramp so that the leading front lip is over the surface on which it is to rest with the stop plates resting against the end of transport vehicle or face of dock. Slowly open the pump release valve (item 22 on page 18) by turning the lever counterclockwise to lower the ramp. Downward movement of the Yard Ramp can be stopped at any point and its lip height held at that level by closing the pump release valve. After the Yard Ramp has settled into place and stopped moving, open the pump release valve completely and leave in open position until ready to raise the Yard Ramp again.

### **WARNING**

Keep loads off of the Yard Ramp with the pump release valve closed.

Do not back the transport vehicle up to and under the lip of the Yard Ramp.

Always move the Yard Ramp to the truck.

### Securing

For safety, always secure the Yard Ramp in place utilizing the two safety chains located on the front of the Yard Ramp. Chains should be looped around a sturdy part of the carrier, platform, or dock on which the Yard Ramp is resting, using the grab hooks to complete the loop. The chains should be as tight and as horizontal as possible, but allow for change in vehicle height caused by shifting loads. Secure the transport vehicle, set the parking brakes then use wheel chocks or other means.

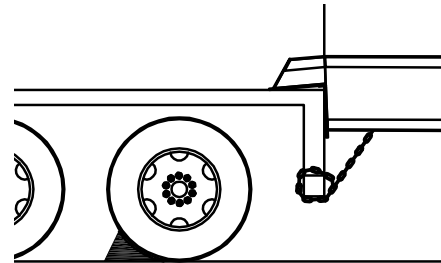

Figure 9 - Safety Chains

### Using

Vehicles traveling on the Yard Ramp should always maintain a slow, steady speed, preferably in low gear. They should not stop or change gears while on the Yard Ramp, as this may cause excessive wear and damage to the vehicle tires. Forklifts should ascend and descend with their forks tilted back and raised enough to avoid contact with the Yard Ramp platform.

### Storage

When finished using Yard Ramp:

1. Release the safety chains and place them securely on platform of Yard Ramp.
2. Close pump release valve (item 22 - page 18).
3. Insert pump handle and actuate pump until lip of Yard Ramp is clear of truck/trailer.
4. Roll Yard Ramp away from platform, dock, or vehicle. Trucks may be driven away from the Yard Ramp, but not before steps 1 through 3 above have been performed.
5. Open pump release valve (item 22 - page 18) slowly.
6. Lower Yard Ramp to stored position.
7. Close pump release valve (item 22 - page 18) and vent plug/drain cock (item 34 - page 18).
8. Replace pump handle into holder on the side of the Yard Ramp.



# MAINTENANCE

---

## Maintenance Precautions

### **DANGER**

It is recommended and good safety practice to use an additional means to support the dock platform and lip anytime when physically working in front of or under the dock leveler. This additional means may include, but is not limited to a boom truck, fork truck, stabilizing bar or equivalent.

### **WARNING**



Always post safety warnings and barricade the work area at dock level and ground level to prevent unauthorized use of the unit before maintenance is complete.

### **WARNING**

A hard hat or other applicable head protection should always be worn when working under or around a dock leveler.

Always stand clear of platform lip when working in front of the dock leveler.



## Periodic Maintenance

### Biannual Maintenance

#### Lubrication

Under normal conditions and environment, the Yard Ramp should be lubricated every six months.

- Lubricate wheel hubs with waterproof automotive grease by using standard “zerk” grease gun.
- Pivot pins of wheel undercarriage may be oiled with SAE30 Motor Oil.

#### Tires

##### **Solid Profile Tires (Standard Equipment)**

- These tires are virtually maintenance free.
- Tires can develop flat spots if left standing under load for extended periods, especially in hot weather. This can be prevented by resting the Yard Ramp lip on a stable support and releasing the hydraulic pressure, thereby taking load off of the tires.

**Pneumatic Tires (Optional):** Maintain air pressure of 100 psi.

#### Hydraulics

- Inspect hydraulic system for evidence of damage and leaks.
- Check oil level in pump reservoir. See “Hydraulic System Notes” (starting on page 20), and refer to the Enerpac Owners Manual.

#### Structure

Welded Yard Ramp structure should be inspected at least annually (or more often, according to usage) for evidence of damage and wear, including, but not limited to:

- Cracks/failures in materials or welds.
- Steel work should be repainted as required.

#### Removing Wheels

- Elevate Yard Ramp to its maximum height.
- Lift lip of Yard Ramp with fork truck until wheels are off of the ground, and place supports underneath leading lip edge to hold Yard Ramp securely in that position.
- Remove nut and washer from axle. Remove bolt axle to free wheel.
- **Note** the relative positions of the spacers and washers so they can be replaced in the same locations. When reinstalling the wheel, be sure not to over-tighten bolt axle. Over-tightening bolt axle will prevent the wheel from rolling freely. Being too loose or too tight will result in bearing damage.

#### Replacing Bearings (if applicable)

- Remove wheel per instructions.
- Then remove seal and bearing from the hub.
- Replace with new bearing and seal if necessary.
- Lubricate thoroughly with grease zerk after wheel and axle assembly has been installed.

#### Patching Pneumatic Tire

- Remove wheel per instructions.
- Disassemble rim from hub and remove bolts that join the two halves of the rim together.
- Remove flap and tube.
- Repair with automotive tire patch as required.
- Reverse above procedure to reassemble. Inflate tire to 100 psi.

#### Oil

Enerpac strictly recommends use of Enerpac fluid. Use of anything else will VOID warranty. Enerpac oil type is identified as 1507.

#### Filling Oil Reservoir

Reservoir in pump should be filled only when the Yard Ramp is in a fully lowered position (cylinders retracted, not extended) and the pump release valve is open. Remove filler plug (item 14 on page 18) on top of pump and fill reservoir with oil. Replace filler plug and tighten until finger tight. Filler plug furnished with pump has an integral vent with a check valve that will allow excess oil to escape if the reservoir is overfilled.

# MAINTENANCE

---

## Periodic Maintenance (continued)

### Bleeding Hydraulic System of Air

Air becomes entrapped in the system only when hydraulic connections are disconnected, when the pump is operated with the oil low in the reservoir, or when there are leaks in the system.

After filling the reservoir, it may be necessary to bleed the system of entrapped air. The Yard Ramp must be in its fully lowered position. Loosen the hose connection at one cylinder and slowly operate the pump with pump release valve closed until no air is noticeable in the oil. Retighten the hose connection and refill the pump reservoir. Repeat the process for the other cylinder.

### Pump Release Valve

The hydraulic pump is equipped with an internal pressure relief valve, which is adjusted at the factory to hold the Yard Ramp elevated with no load. If the Yard Ramp tends to settle, and there is no apparent leakage in the system, the relief valve may have to be readjusted for a slightly higher bypass pressure. Access for this adjustment is obtained by removing the base cover. Increase relief pressure by turning the adjustment screw (or nut) one quarter turn clockwise. Reassemble and test for proper operation. Repeat if necessary.

### Pump Release Valve Handle

If rotation is limited by the handle hitting the pump base and valve cannot be completely closed (or sufficiently opened), the handle can be repositioned on its shaft by removing the screw in the end of the shaft, sliding the handle off, and reassembling in the proper position. Be sure the packing nut around valve shaft is properly tightened.

### Flow Control Valve

A flow control valve at the hose connection to each cylinder allows oil to flow to the cylinder without restriction but restricts the flow away from the cylinder. This provides a means of reducing the rate at which the Yard Ramp lowers when the pump release valve is opened. This slower lowering rate prevents damage to the Yard Ramp that can be caused by dropping it via quickly opening the pump release valve or by failure of a hydraulic component (i.e. hydraulic hose).

### Hydraulic Cylinder

Push rod should have a light/thin coat of oil on its surface. If an excessive amount does appear, check the adjustment of the piston packing nut and correct as necessary. If there is doubt about packing nut adjustment, elevate the Yard Ramp by means of the pump and place supports underneath the leading lip edge so that the Yard Ramp is held in position. With the pump release valve closed and pressure on the system, slowly loosen the packing nut on one cylinder until oil flows out and then immediately retighten until the flow stops. **DO NOT OVER-TIGHTEN.** Check oil level in reservoir and fill if necessary. Raise and lower ramp several times in a normal manner and observe movement of cylinder push rods for evidence of binding, which will occur if packing nut is too tight.

If leak continues, the cylinder should be removed and examined for a scored push rod or faulty packing and wipers. Repair or replace as required. See PARTS section.

### Removing Hydraulic Cylinder

Elevate Yard Ramp up to its maximum height. Then place supports able to handle 2000 pounds underneath the leading lip edge of the Yard Ramp to hold it securely at 1 inch from maximum height. Slowly release pressure in hydraulic system and allow Yard Ramp to slowly settle onto supports, then rotate pump release valve handle to fully open position. Remove retaining rings and washers from pivot pins at ends of cylinder and push out the pins. Remove cylinder, compress cylinder to expel hydraulic fluid back into system, disconnect hydraulic hose from cylinder, and seal end of hose to keep out foreign objects. Repair or replace cylinder as required, reconnect hydraulic hose, but do not tighten fitting, and reassemble into Yard Ramp. Be sure pump release valve is fully open, then with forklift truck, lift lip of Yard Ramp clear of supports, remove supports, and slowly lower lip of Yard Ramp to minimum height. Fill reservoir in pump. Close pump release valve and slowly actuate pump to force air out of the system. Tighten hydraulic hose fitting at cylinder when all of the air is out. Check level of fluid in pump reservoir and fill as required.

## **Periodic Maintenance (continued)**

### **Removing Hydraulic Pump**

Elevate Yard Ramp up to its maximum height. Then place supports able to handle 2000 pounds underneath the leading lip edge of the Yard Ramp to hold it securely at 1 inch from maximum height. Slowly release pressure in hydraulic system and let Yard Ramp slowly settle onto supports, then rotate pump release valve handle to fully open position. Disconnect hydraulic hose from pump and seal end of hose to keep out foreign objects. Remove (4) mounting bolts and remove pump. Repair or replace pump as required, remount, and reconnect hydraulic hose. Be sure pump release valve is fully open, then with forklift, lift lip of Yard Ramp clear of supports, remove supports, and slowly lower lip of Yard Ramp to minimum height. Then bleed air from system according to specified procedure.

# TROUBLESHOOTING

---

## **DANGER**

It is recommended and good safety practice to use an additional means to support the dock platform and lip anytime when physically working in front of or under the dock leveler. This additional means may include, but is not limited to a boom truck, fork truck, stabilizing bar or equivalent.

## **WARNING**

Always post safety warnings and barricade the work area at dock level and ground level to prevent unauthorized use of the dock leveler before maintenance is complete.

A hard hat or other applicable head protection should always be worn when working under or around a dock leveler.

Always stand clear of platform lip when working in front of the dock leveler.

### **Problem: Yard Ramp does not rise when pump is actuated.**

Possible reasons/solutions:

1. Physical or mechanical damage to wheel undercarriage or hydraulic system.
2. No oil in pump reservoir. Fill if required and check for leaks. Refer to Enerpac manual.
3. Pump release valve not completely closed. If free end of handle is in contact with pump base when rotated clockwise, the valve may not be completely closed. Reposition handle on shaft.
4. Pressure relief valve not properly adjusted. Pump handle will have normal resistance on power stroke, but Yard Ramp will not rise, or attempts to rise and then settles back. Readjust pressure relief valve.
5. Oil leaks. Repair as required.
6. Pump check valves clogged or out of adjustment. Pump handle has normal resistance and Yard Ramp rises on power stroke, but handle returns by itself and Yard Ramp drops. See accompanying drawing of hydraulic pump for location of check valves and clean, repair, or adjust as required.
7. Load on the Yard Ramp. Hydraulic system, wheel structure, and wheels are designed to raise and support only the weight of the Yard Ramp.

### **Problem: Yard Ramp does not lower when pump release valve is opened.**

Possible reasons/solutions:

1. Physical or mechanical damage to wheel undercarriage or hydraulic system.
2. Pump release valve handle is hitting pump base and not opening.
3. Flow control valves clogged.
4. Obstructed or inoperative vent in vented filler plug of pump.
5. Oil reservoir overfilled, thereby leaving insufficient air cushion in non-vented reservoir.
6. Hydraulic cylinder packing nuts too tight.
7. Hydraulic cylinder push rods bent or damaged.

### **Problem: Yard Ramp rises extremely slowly or is hard to pump.**

Possible reasons/solutions:

1. Hydraulic hoses might be kinked or have an internal obstruction.
2. Filter screen on pump suction might be obstructed.
3. Wheel structure might be damaged.
4. Pump check valve clogged or out of adjustment.
5. Hydraulic cylinder packing nuts too tight.
6. Pump release valve not completely closed. If free end of handle is in contact with pump base when rotated clockwise, the valve may not be completely closed. Reposition handle on shaft.
7. Pump reservoir filled with oil of higher viscosity than specified.

**Problem: Yard Ramp settles.**

Possible reasons/solutions:

1. Check for hydraulic leaks in system.
2. If there are no leaks evident in the hydraulic system, it might be necessary to readjust the pump's internal pressure relief valve for a slightly higher pressure. This factory-preset valve is located inside the reservoir. Consult Enerpac 414-781-6600.

**Problem: Excessive oil leakage around pump.**

Possible reasons/solutions:

1. Reservoir overfilled (filled when Yard Ramp was not in fully lowered position) and excess oil was forced out of vent in filler plug, or out from around the filler plug when Yard Ramp was lowered.
2. Yard Ramp lowered too quickly, which can build up pressure in reservoir and force oil out through vent in filler plug or out from around the filler plug. Yard Ramp should be lowered by slowly opening the pump release valve.
3. Pump Piston packing leaking. Replace packing if necessary. Adjust packing nut.
4. Pump release valve shaft packing leaking. Adjust nut or replace packing if necessary.
5. Cracked pump body, probably caused by overfilled oil reservoir. Pump reservoir is NOT designed to contain oil under high pressure. The pressure of oil returning to the reservoir is relieved by air and excess oil escaping through the vented filler plug of a vented reservoir or by compressing the air cushion in a non-vented system. Restriction of the vent, insufficient air cushion, or a too rapid buildup of pressure caused by "dropping" the Yard Ramp can increase this pressure beyond that which the reservoir can contain.

**Problem: Broken or burst hydraulic hoses, cylinders, etc.**

Possible reasons/solutions:

1. Caused by operating vehicles on Yard Ramp with pump release valve closed. **Hydraulic system, wheel structure, and wheels are designed to raise and support only the weight of the Yard Ramp. Yard Ramp settles.**

---

**For additional hydraulic troubleshooting, contact Enerpac at 414-781-6600.**

# PARTS

## Pump

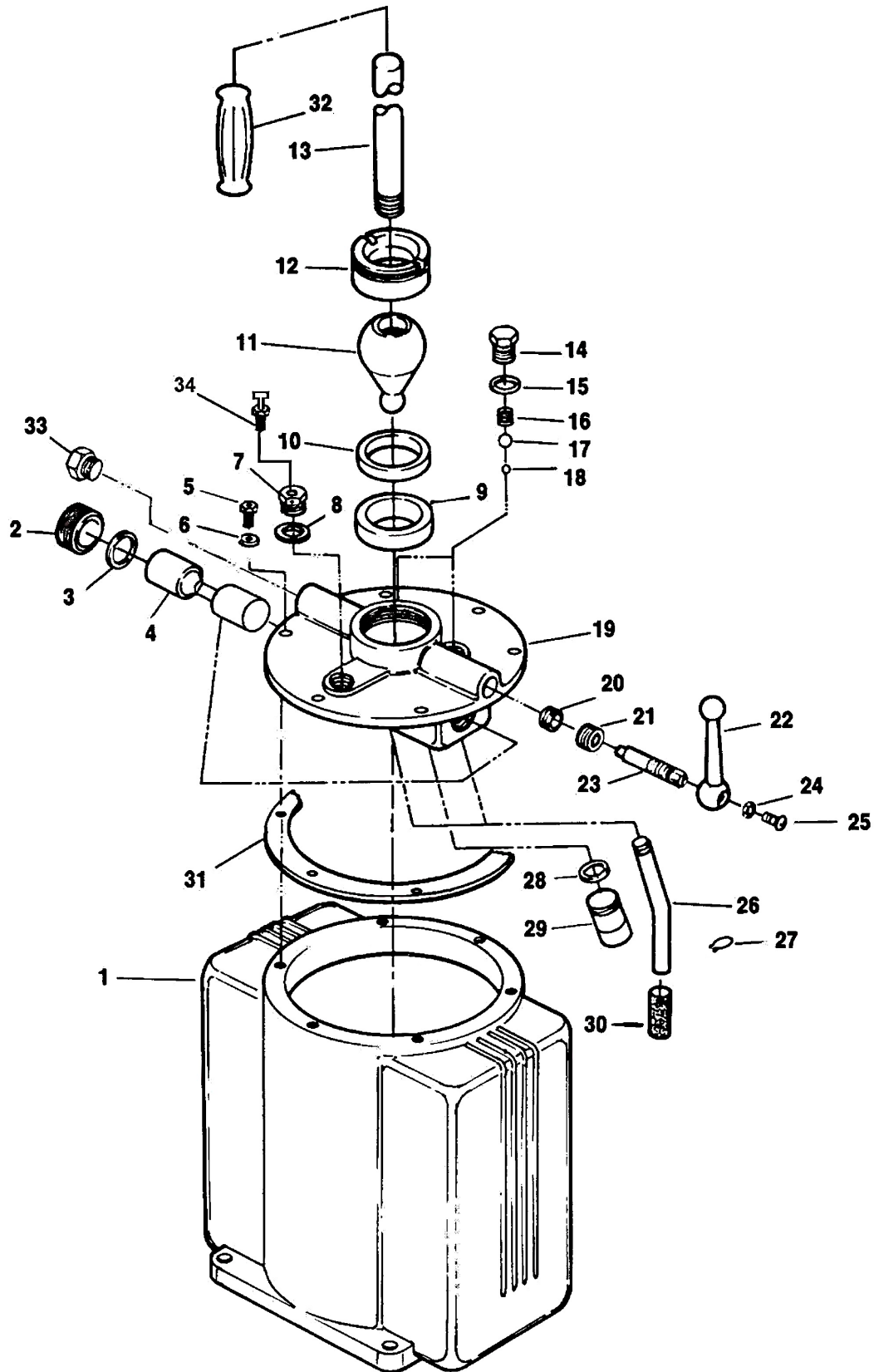

## Pump

The Enerpac P-50 pump is used on all Yard Ramps.

Item	Quantity	Part Number	Description
*	1	<b>DOTH-2873</b>	<b>Complete Pump, Enerpac P-50</b>
1	1	P6005	Reservoir
2	2	P6006	Plug
3	2	*	Gasket
4	1	P6051-1	Piston
5	6	Standard Hardware	Cap Screw 1/4-20 UNCx5/8 Lg.
6	6	Standard Hardware	Lock Washer 1/4 bolt
7	1	CA365024SR	Vent Plug (incl. Item 8)
8	1	*	Gasket
9	1	P60306	Seat
10	1	*	Packing
11	1	P60234-1SR	Rocker Arm (incl. Item 9,10,12)
12	1	P60307	Cap
13	1	A1016070	Handle
14	2	W12185SR	Plug (incl. Item 15)
15	2	*	Gasket
16	2	*	Spring
17	2	*	Ball
18	2	*	Ball
19	1	141264SR	Pump Head Assembly
20	4	*	Packing
21	1	P6011	Nut
22	1	P6012\SR	Lever (incl. Item 24,25)
23	1	P6010	Release Valve Spindle
24	1	P45139	Washer
25	1	P45138	Screw
26	2	P60268	Oil Tube
27	2	A8061049	Retaining Ring
28	1	*	Gasket
29	1	P181190W	Relief Valve
30	2	A80818018	Screen
31	1	*	Reservoir Gasket
32	1	CJ46550	Grip
33	1	A8069006	Pipe Plug
34	1	CA651024	Drain Cock

\*Indicates items included in and available only as part of Repair Kit P50K1.

# PARTS

## Hydraulic System

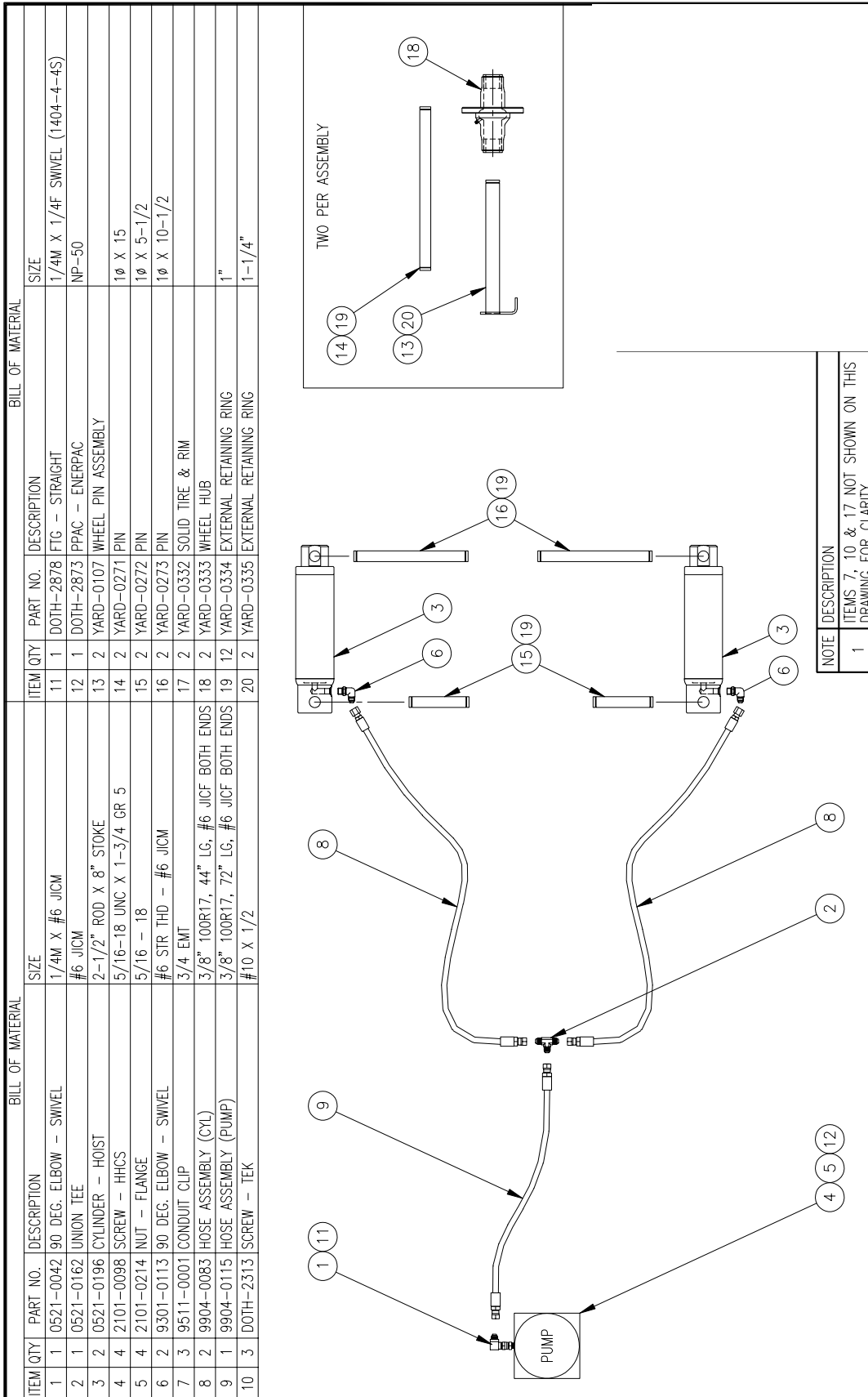



## Customer Information

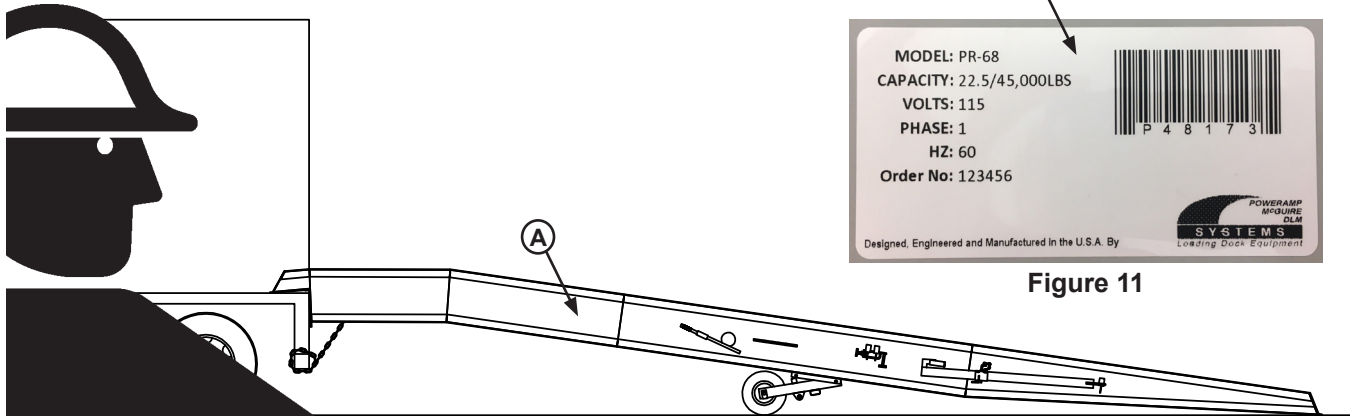

Figure 10

Figure 11

*NOTE: Refer to Figure 10 for left/right orientation of Yard Ramp and Figure 11 for example of decal.*

*The model/serial number decal is located on the left side of the Yard Ramp (A).*

When you receive your new equipment, write down the model and serial number in the form provided. This will help ensure safe keeping of the numbers in the event the model/serial number decal (A, B) becomes lost or damaged.

Also, write down Systems, LLC's order number, the company that installed the equipment, and the original owner's name. This will all help to identify the specific equipment if more information is required.

When ordering, use part numbers and description to help identify the item ordered. Do not use "item" numbers. These are only for locating the position of the parts. Always give MODEL NUMBER and/or SERIAL NUMBER.

For service, call or contact:

Systems, LLC  
P.O. Box 309  
Germantown, WI 53022

Phone: (800) 643-5424  
Fax: (262) 255-5917

[www.loadingdocksystems.com](http://www.loadingdocksystems.com)

### Dock Leveler Information

Model \_\_\_\_\_

Serial No. \_\_\_\_\_

Systems, LLC, Job No. \_\_\_\_\_

### Vehicle Restraint Information

Model \_\_\_\_\_

Serial No. \_\_\_\_\_

Systems, LLC Order No. \_\_\_\_\_

### Original Owner Information

Name \_\_\_\_\_

Address \_\_\_\_\_  
\_\_\_\_\_

### Installer Information

Name \_\_\_\_\_

Address \_\_\_\_\_  
\_\_\_\_\_

Date of Installation \_\_\_\_\_

## **STANDARD PRODUCT WARRANTY**

SYSTEMS, LLC warrants that its products will be free from defects in design, materials and workmanship for a period of one (1) year from the date of shipment. All claims for breach of this warranty must be made within 30 days after the defect is or can with reasonable care, be detected. In no event shall any claim be made more than 30 days after this warranty has expired. In order to be entitled to the benefits of this warranty, the product must have been properly installed, maintained and operated in accordance with all manufacturer's recommendations and/or specified design parameters and not otherwise have been subject to abuse, misuse, misapplication, acts of nature, overloading, unauthorized repair or modification, application in a corrosive environment or lack of maintenance. Periodic lubrication, adjustment and inspection in accordance with all manufacturers' recommendations are the sole responsibility of the Owner/User.

In the event of a defect, as determined by SYSTEMS LLC, covered by this warranty, SYSTEMS LLC shall remedy such defect by repairing or replacing any defective equipment or parts, bearing the cost for the parts, labor and transportation. This shall be exclusive remedy for all claims whether based on contract, negligence or strict liability.

## **WARRANTY LIMITATIONS**

THE ABOVE WARRANTIES ARE IN LIEU OF ANY OTHER WARRANTIES, WHETHER EXPRESSED OR IMPLIED, INCLUDING BUT NOT LIMITED TO ANY IMPLIED WARRANTY OF MERCHANTABILITY OR FITNESS FOR A PARTICULAR PURPOSE. SYSTEMS LLC AND ITS SUBSIDIARIES SHALL NOT IN ANY EVENT BE LIABLE TO ANYONE, INCLUDING THIRD PARTIES, FOR INCIDENTAL, CONSEQUENTIAL OR SPECIAL DAMAGES OF ANY KIND INCLUDING BUT NOT LIMITED TO, BREACH OF WARRANTY, LOSS OF USE, LOSS OF PROFIT, INTERRUPTION OF BUSINESS OR LOSS OF GOODWILL.